

■ ENCOFRADO · FORMWORK · COFFRAGE

TABICAS PERIMETRALES
RETAINING WALLS
COFFRAGE DE BAD DE DALLE

Soporte anclaje giratorio plegable para un almacenamiento y transporte fácil.

Folding support for an easy warehousing and transportation.

Supports pliables pour aisés stockage et transport.

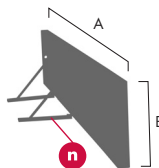
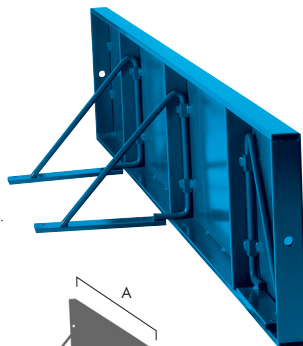

REF.	A mm.	B mm.	n	Kg.
1	1000	300	2	8,7
2	2000	300	3	16,2
2,5	2500	300	4	20,2
3	3000	300	5	

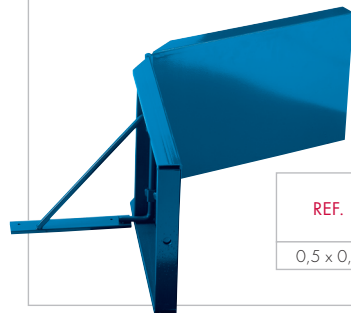

PERIMETRAL ÁNGULO
ANGLE RETAINING WALL
RIVES ANGLES

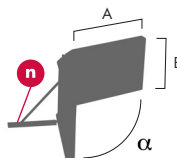

REF.	A mm.	B mm.	n	α	Kg.
0,5 x 0,5	500	300	2	0 - 300°	9,3

Grapa unión · Union clamp · Crampon



Kg.
0,15

COMPENSADOR PERIMETRAL
COMPENSATORY RETAINING WALL
RIVE DE JONCTION

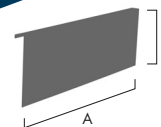
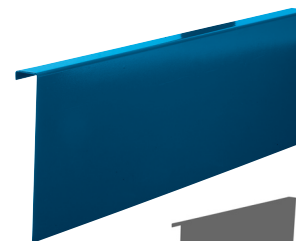

A mm.	B mm.	⚡	Kg.
1000	300	2	6,4

■ H ENCOFRADO · H FORMWORK · H COFFRAGE



Para encofrados rápidos y simples.
For quick and simple formwork structures.
Idéal pour un coffrage rapide et simple.

REF.	A mm.	B mm.	Kg.
27	200	460	3,1

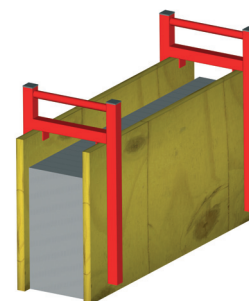
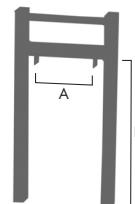

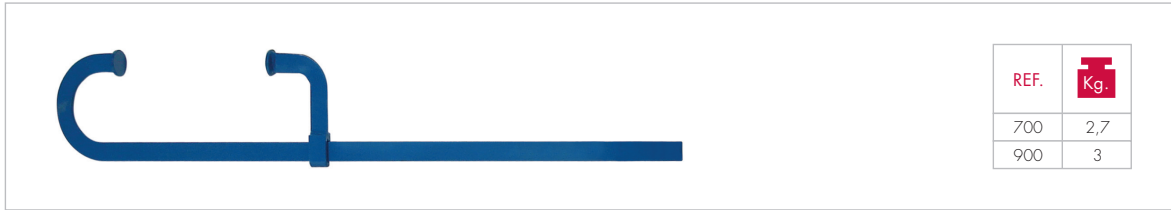

■ ACCESORIOS DE ENCOFRADO
FORMWORK ACCESSORIES
ACCESSOIRES COFFRAGE

Acero forjado cincado.
Carga de trabajo 75 kN.
Carga de rotura superior a la varilla roscada.
ZN forged steel.
Working load of 75 kN.
Ultimate load superior to tie rod.

Acier forgé zingué.
Charge de travail 75 kN.
Charge de rupture supérieur à la tige filetée.



VARILLA DYWIDAG · TIE ROD · TIGE FILETÉE ■

